



# Framing Coordination

From Transdisciplinary Models  
to Infrastructures and Tools for MAS Engineering

**Andrea Omicini, Alessandro Ricci**

DEIS, Università degli Studi di Bologna, Cesena, Italy

Seconda Facoltà di Ingegneria

[aomicini@deis.unibo.it](mailto:aomicini@deis.unibo.it), [aricci@deis.unibo.it](mailto:aricci@deis.unibo.it)

# Outline

- Motivations
- The Whole Mess of Coordination
- The Coordination Sieve
- Framing Coordination with the Sieve
- Final Remarks

# Motivations

- Motivations
  - MAS, Complexity & Coordination
  - (Too) Many (Un-coordinated) Viewpoints over Coordination
  - The Technology Galore
- The Whole Mess of Coordination
- The Coordination Sieve
- Framing Coordination with the Sieve
- Final Remarks

# MAS aka Complex Systems

- Main agent features in this context
  - Autonomy
  - Society
  - Environment
- From Agent to Multi-Agent Systems
  - Organisation & Coordination
- MAS as tools for
  - Modelling
  - Engineering

## Complex Systems

# Complexity & Coordination

- What is **complex**?
  - if it has a simple model / explanation, it is not complex
  - SE problem: conceptual integrity undermined in principle
- Sources of complexity
  - multiplicity of heterogeneous components
  - unpredictable behaviours
  - interaction
- Making system components work together effectively and fruitfully
  - focus on **interaction** and its **management**
  - beyond communication, interoperability, conversations
  - beyond the reductionist vision, toward **systemic** vision
    - no way to govern large system based on individual / peer interactions
    - there is something beyond the sum of the individual parts

# Different Viewpoints (1)

- MAS for
  - modelling complex systems
  - engineering complex systems
- ≡ Coordination as modelling / engineering interaction
- Computer Scientists vs. Engineers
  - models, theories, technologies
  - methodologies, best practices, tools

# Different Viewpoints (2)

- Engineers are troubled by complexity
  - complexity as a source of richness or problems?
  - e.g., enabling vs. protecting
    - open vs. closed systems
    - security as a form of coordination
- How to deal with
  - autonomy (of components / agents)
  - openness (of societies)
  - unpredictability (of the environment)

# Different Viewpoints (3)

- Agent's v. Designer's Viewpoint
  - each agent coordinates
    - trying to understand its best path towards its own goals
    - interacting with other agents and the environment
    - according its own goals, desire, intentions, beliefs, knowledge, capabilities
  - each designer coordinates agents and the whole system
    - trying to make it behaves globally as required
    - based on / despite of agent's autonomous behaviour
    - according to his/her knowledge / understanding of both agent's and system's behaviour
- Coordination as either
  - an agent activity
  - an activity over agents
- Agents as either
  - coordinating, or
  - coordinated entities
- Design-time vs. Run-time System Organisation



# “Qualities” of Coordination

- Identifying main dimensions and properties
  - expressiveness
  - scalability
  - correctness
  - formal representation / verification
  - effectiveness
  - efficiency
    - in performance & representation
  - qualitative and quantitative measurability
  - maintainability
- (Different) Relevance to scientists and engineers
  - have led to different approaches in technologies, too

# Pervasiveness of Coordination

- Contexts
  - Interoperability
  - Communication
  - Cooperation
  - Coordination
  - Negotiation
  - Integration
  - Orchestration
  - ....
- Research Areas
  - OK, we cannot even try listing them, really
  - so many
    - even (particularly?) out of the AI/CS/SE triangle
- Different / Overlapping / Confusing definitions

# Technologies Galore

- Huge number of technologies proposed
  - to make system components work together etc.
- Heterogeneous contexts & diverse abstraction/technology levels
- Examples of coordination-related technologies:
  - Integrating and coordinating services
    - Jini, OSGi, Java Spaces, TSpaces, ...
  - Specifying and enacting workflow
    - WfMC architecture, Workflow Languages
      - XPDL, BPML, ...
  - Supporting Groupware
  - Composing and Orchestrating web services
    - Orchestration servers, Orchestration Languages
      - BPEL4WS
  - Integrating wireless technologies
    - BlueTooth, ZeroConf,...

# Example: Wireless technologies

- Integrating and coordinating autonomous wireless devices
- Bluetooth (IEEE 802.15.1)
  - simple coordination capabilities in the basic radio technology
    - master / slaves
    - piconet / scatternet
      - gateways
    - automatic discovery & configuration of peer devices
- ZeroConf (Rendezvous)
  - service-oriented coordination protocol
  - upon different radio / connection technologies
    - Ethernet, WiFi, Bluetooth, ...
  - transparent & automatic discovery of user services

# Example:

## Service-Oriented Architectures

- Integrating and coordinating software independent services
  - Pervasive computing contexts
    - Intelligent / smart home
- Specification and platform
  - OSGi
  - Jini
- Coordination technologies
  - JavaSpaces
  - TSpaces

# Example:

## Distributed Workflow Management

- Automating the specification and enactment of business processes
  - coordination of distributed independent and heterogeneous tasks cooperating in the same workflow
  - coordinating humans and machines
- Workflow architectures
  - workflow specification and enactment services
    - workflow engines
- Workflow Specification languages
  - XPDL, BPML, ...
- Virtual Enterprises / Organisations

# Example:

## Component Integration & Coordination

- Shift
  - from the individual components to the their “containers”
    - that glue components offering services which eventually manage component interactions (i.e. coordination services)
      - transactions, concurrency, persistence, ...
  - infrastructure view
- Application Servers
- CORBAcomponents, Enterprise Java beans, .NET components

# Example:

## Web Services Orchestration

- Shift
  - from the individual Web services to composition of web services
    - though enactment services (engines) that glue multiple individual services in the same orchestration (workflow)
- Choreography/Orchestration servers
  - specification and enactment
- Choreography/Orchestration languages
  - BPEL4WS, WSCI, ...



# Remark

- The (Coordination) Technology galore
  - poses more issues than the mere technology one
  - every technology / infrastructure / tool
    - embodies / reifies a model
    - support / promotes a methodology or a practice
    - either explicitly or implicitly
  - i.e., they affect the whole spectrum of engineering
- Answers at the technology level are typically
  - very focused & specialised
    - easy to recognise similar issues everywhere
    - with similar answers
    - but developed separately & independently
      - very exciting, not very intelligent

# The Whole Mess of Coordination

- Motivations
- **The Whole Mess of Coordination**
- The Coordination Sieve
- Framing Coordination with the Sieve
- Final Remarks

# Academia Galore

- Lots of heterogeneous models & surveys for facing the whole mess of coordination
- Lots of individual good results but
  - Typically, no points of contact between two different surveys
  - People tend to take religious standpoints

# Several Definitions...

- “Coordination is the process by which an agent reasons about its local actions and the (anticipated) actions of others to try and ensure the community acts in a coherent manner” (Jennings, 1998)
- “Coordination as management of dependencies between independent activities” (Malone et al, 1994)
- “[Coordination as the activity that] involves the selection, ordering and communication of the results of agent activities so that an agent works effectively in a group setting..” (Lesser, 1998)
- “co-ordination is a process in which agents engage in order to ensure a community of individual agents acts in a coherent manner” (Nwana et al, 1996)
- “[Coordination as] a way of adapting to the environment” (Von Martial, 1992)

# Several Surveys & Books...

- Surveys
  - “DAI Approaches to Coordination” (Gasser)
  - “Coordination of Internet Agents: Models and technologies” (Papadopoulos)
  - “Models of Coordination” (Tolksdorf)
  - “Co-ordination in software agent systems” (Nwana et al.)
  - “Coordination models: a guided tour” (Busi et al.)
  - “Reusable patterns for agent coordination” (Kendall et al.)
  - ...
- Books
  - “Co-ordination in artificial agent societies” (Ossowski)
  - “Coordination of Internet Agents” (Omicini et al.)
  - ...

# Coordination Everywhere...

- Reference example: "Multiagent Systems: A modern approach to DAI" (Weiss, 1999) book
  - Coordination spread in several chapters
    - Huns and Stephens' section on coordination
      - Coordination as a 'subsection' of communication (2.2 Agent Communication, 2.2.1 Coordination...)
    - Durfee's chapter of Distributed Problem Solving and Planning
      - Related to distributed planning and execution
    - Singh's chapter on formal methods in DAI
      - coordination section
    - Agha's chapter on Concurrent Programming
      - section on coordination in agents' ensemble
    - Ellis's chapter of CSCW and Groupware
      - section(s) on coordination

# Coordination from DAI...

- (Edmund Durfee, "Organizations, Plans and Schedules: An Interdisciplinary Perspective on Coordinating AI Agents", *Journal of Intelligent Systems*, Special Issue on the Social Context of Intelligent Systems, 3(2-4):157-187, 1993)
- **General view: AI and Social / Organisational Sciences are inextricably related**
  - coordination in a MAS as fundamental to intelligence
  - individual and collective intelligence
- **Coordination as a distributed search problem**
  - search space as a common representation for organisation, plans & schedules
    - global shared plan / organisation
  - foundation for strong interdisciplinarity

# ...toward MAS

- (Victor Lesser, "Reflections on the Nature of Multi-Agent Coordination and Its Implications for an Agent Architecture", JAAMAS 1998)
- **Coordination: supporting / promoting agent activities as a collective**
  - scheduling, detection, learning, ...
  - moving from individual to social viewpoint
    - Organisation
      - roles & responsibilities
      - limiting required info and deliberation scope
    - Architectural concepts
      - support for communication is not enough (KQML)
  - Focus on **infrastructures**



# Coordination Approaches Galore

- Approaches rooted in Distributed Artificial Intelligence (DAI)
- Approaches coming from Software Engineering contexts
  - more focus on infrastructure support to coordination
- Approaches using Economics Metaphors
- Approaches founded on Social Control and Institutions
- Approaches based on Coordination Media & Languages
- Coordination through the Environment
  - swarming & stigmergy coordination
- ...

# Coordination as Distributed problem Solving

- (Keith Decker, "Coordinating Intelligent Agents", Foundations and Applications of Multi-Agent Systems 2002: 1-18)
- (Keith Decker, "TAEMS: A Framework for Environment Centered Analysis & Design of Coordination Mechanisms". In *Foundations of Distributed Artificial Intelligence, Chapter 16* , pp. 429–448. January, 1996)
- (Lesser, V.; Decker, K.; Wagner, T.; Carver, N.; Garvey, A.; Horling, B.; Neiman, D.; Podorozhny, R.; NagendraPrasad, M.; Raja, A.; Vincent, R.; Xuan, P.; Zhang, X.Q. Evolution of the GPGP/TAEMS Domain-Independent Coordination Framework . In University of Massachusetts/Amherst Computer Science Technical Report , Number 02-03. January, 2002)
- Coordination as managing tasks / interdependencies
  - PGP, GPGP
  - TAEMS (Task Analysis and Environment Modeling System)
- Formal / complex model
  - actions & task, non-local effects, task structures
  - global planning / scheduling
  - coordination mechanisms as (formal) algorithms
- Task structures for
  - reason about coordination
  - communicate about coordination

# Founding Coordination on Commitments and Conventions

- (Nick Jennings, "Commitments and Conventions: The Foundation of Coordination in MAS", The Knowledge Engineering Review 8(3) 1993)
- "Foundation of Coordination"
- Same DAI-vision
  - Coordination as distributed goal search problem
- Basic bricks
  - (joint) commitments & (social) conventions
  - local reasoning
- Frameworks & Technologies
  - (N. R. Jennings, "Controlling Cooperative Problem Solving in Industrial Multi-Agent Systems using Joint Intentions", Artificial Intelligence, 75 (2), 1995, 195-240)
  - GRATE\* system/technology
    - teamwork
  - (N. R. Jennings, T. J. Norman, and P. Faratin, "ADEPT: An Agent-based Approach to Business Process Management", ACM SIGMOD Record 27 (4), 1998, 32-39)
  - ADEPT architecture
    - business process management

# ACL-based Approaches

- (R. Scott Cost, Yannis Labrou, and Tim Finin, "Coordinating Agents using Agent Communication Languages Conversations", in "Coordination of Internet Agents:Models, Technologies, and Applications (A. Omicini ,F. Zambonelli,M. Klusch ,R. Tolksdorf Eds., Springer-Verlag , March 2001)
- **Coordination just upon communication**
  - Patterns of communications
- **Interaction protocols, conversations**
  - Individual viewpoint over coordination
  - Conversations "out of agents"
- **Some assumptions**
  - intelligent, homogeneous agents
  - high-level communication language (KQML, FIPA)
  - closed societies, low cardinality
  - marginal role of the environment
  - communication / coordination between peers / pairs
- **Approaches**
  - COOL (COOrdination Language)

# Coordination Services

- (Munindar P. Singh. “A customizable coordination service for autonomous agents”, In Intelligent Agents IV: Proceedings of the 4th International Workshop on Agent Theories, Architectures, and Languages (ATAL-97), pages 93--106. Springer-Verlag, 1998)
- (Munindar P. Singh. “Synthesizing coordination requirements for heterogeneous autonomous agents”. Autonomous Agents and Multi-Agent Systems, 3(2):107--132, June 2000)
- **Customisable coordination services**

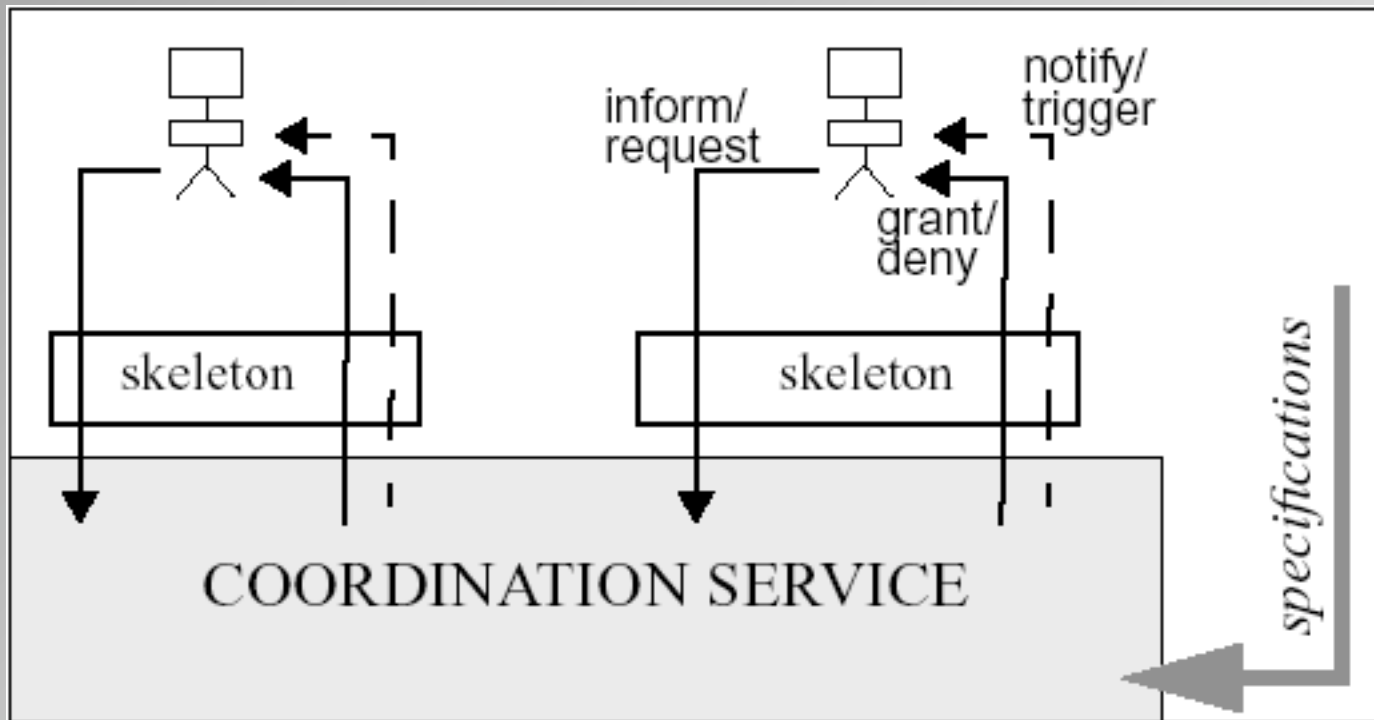

# Team-Oriented Coordination

- (David Pynadath and Milind Tambe, "An automated teamwork infrastructure for heterogeneous software agents and humans Journal of Autonomous Agents and Multiagent Systems (JAAMAS), 2002)
- (Milind Tambe, "Towards flexible teamwork", Journal of Artificial Intelligence Research, 7:83--124, 1997)
- **TEAMCORE**
  - coordination out of agents
    - "proxies" for legacy, "stupid" agents
    - focus on the infrastructure
      - as both enabling and promoting coordination
  - team-oriented programming
    - for developers
    - specification of team organisation hierarchy in terms of role and groups
    - specification of the hierarchy of reactive team plans
    - assignment of agents to plans

# Middle-Agents

- (Katia Sycara, Matthias Klusch, "Brokering and Matchmaking for Coordination of Agent Societies: A Survey", in "Coordination of Internet Agents: Models, Technologies, and Applications (A. Omicini, F. Zambonelli, M. Klusch, R. Tolksdorf Eds., Springer-Verlag, March 2001)
- **Coordination as intermediation**
  - performed by specialised (Middle-)Agents
  - between service providers and requesters (agents)
- **Service-oriented view**
  - brokering in open environment
- **Mediation services**
  - as coordination services
    - processing agent capabilities and service descriptions
    - enabling semantic interoperation between agents and systems
    - management of data and knowledge
    - enacting distributed query processing and transactions
- (J.A. Giampapa and K. Sycara, "Team-Oriented Agent Coordination in the RETSINA Multi-Agent System", AAMAS 2002 Workshop on Teamwork and Coalition Formation)
- **Toward Team-oriented coordination**
  - Coordination as a team problem solving, à la Tambe
  - RETSINA + TAFMS/GPGP

# Market Oriented Coordination

- (Micheal P. Wellman, "A market-oriented programming environment and its application to distributed multicommodity flow problems". Journal of Artificial Intelligence Research, 1:1-22, 1993)
- (Michael P. Wellman. "Market-oriented programming: some early lessons". In S. H. Clearwater, editor, Market-based control: a paradigm for distributed resource allocation, chapter 4. World Scientific, 1995)
- (Fredrik Ygge and Hans Akkermans. "Decentralized markets versus central control: A comparative study". Journal of Artificial Intelligence Research, 11:301--333, 1999)
- Based on Metaphors from Economics Science
  - "Market Oriented Programming"
  - Contract Net Protocol
  - Computational Ecologies (Hubermann and Hoggs)
- Heterogeneous agents
  - not necessarily intelligent ones
  - open societies, high cardinality
  - environment in terms of resources



# Coordination through Social Laws

- (Yoav Shoham and Moshe Tennenholtz, "On Social Laws for Artificial Agent Societies: Off-Line Design", *Artificial Intelligence*, Vol. 73, Numbers 1-2, February 1995, pp. 231-252.)
- Coordination as restriction over agent activity
  - allowing them to reach their own goals
  - avoiding interferences
  - constraining interactions
  - "social laws"
- Social law as built into action representation
  - rather than epiphenomenal
  - implemented as architectural system properties
  - designed off-line
  - explicitly represented (run-time)
- The problem of open societies

# Coordination and Institutions

- (V. Dignum, F. Dignum, "Modeling agent societies: co-ordination frameworks and institutions", Progress in Artificial Intelligence. P. Brazdil, A. Jorge (eds.), Proceedings of the 10 th Portuguese Conference in Artificial Intelligence. Lecture Notes in Artificial Intelligence , Springer-Verlag, Volume 2258, 2001.)
- **Organisation**
  - social order
  - global behaviour emerging from individual interactions
    - how to make individual goals coexist with global ones
- **Coordination frameworks to cope with duality**
  - rules and infrastructures
- **Norms and Institutions**
  - to cope with the challenge of social order
  - in open societies
  - explicitly represented and embodied out of agents
  - in general Institutions make it possible to
    - specify the co-ordination structure that is used
    - describe exchange mechanisms of the agent society
    - determine interaction and communication forms within the agent society
    - facilitate the perception of individual agents of the aims and norms of an agent society
    - enforce the organisational aims of the agent society

# Coordination as a Service: TuCSoN

- (A. Omicini and F. Zambonelli. "Coordination for Internet Application Development", Autonomous Agents and Multi-Agent Systems 2(3) .Kluwer Academic Publishers , September 1999)
- (A. Omicini and E. Denti. "From Tuple Space to Tuple Centre", Science of Computer Programming, 41(3), Elsevier Science B.V., Nov. 2001)
- (A. Omicini, "Towards a Notion of Agent Coordination Context", Process Coordination and Ubiquitous Computing, Chapter 12, CRC Press , October 2002)
- **TuCSoN coordination model/infrastructure**
  - **Tuple Centres**
    - general purpose customizable coordination services
      - programmable logic tuple spaces
        - » generative communication
        - » ReSpecT language for coordination specification
      - enacting/enforcing coordination laws & constraints
    - spread over the TuCSoN nodes
      - Network awareness
      - Agent mobility
  - **Agent Coordination Contexts**
    - enabling and ruling agent access/use of the services
    - Organisation & security issues
  - **Orthogonal to the agent model/platform**
    - **TuCSoN and friends**

# Coordination through the Environment: Stigmergy Coordination

- (Parunak, "Experiments with Indirect Negotiation" in "Negotiation Methods for Autonomous Cooperative Systems" - AAAI Fall Symposium - Nov. 2001)
- Coordination enabled and mediated by the environment
  - environment as a shared space for indirect communication
    - coordination through the environment
  - support for open, & heterogeneous agent societies
  - overcomes the problems and limitations of individual viewpoint and knowledge
  - it intrinsically embeds domain constraints
- No need for direct symbolic communication among agents
- Prescriptive
  - "Entropy and Self-Organization in MAS" (Parunak, Brueckner) Agents 2001
- Pheromone-based model of coordination
  - Measuring coordination

# Swarming Intelligence

- (Bonabeau et al, "Swarm Intelligence: from Natural to Artificial Systems", Oxford Univ., 1999)
- Distributed problem-solving devices inspired by collective behaviour of social insect colonies and other animal societies
  - From natural systems
    - global robust intelligent behaviour
    - with simple & non-intelligent individuals
    - intelligence in the interaction / coordination
      - among agents, and with the environment
- Self-organisation by local interactions
- Stigmergy as a subset
- (Marco Mamei, Franco Zambonelli, Letizia Leonardi, "Co-Fields: Towards a Unifying Approach to the Engineering of Swarm Intelligent Systems", ESAW 2002 : 68-81)
- Co-field (coordination field)
  - unifying approach

# Remarks

- Coordination is neither an AI nor a CS problem
  - It concerns complex systems
    - where both complexity and system are notions of heterogeneous nature according to the field of interest
  - There are branches of science that work on complex systems since long before we (AI, CS, SE, MAS, whatever) did
    - They are to some extent more science than we are
    - They have results

# Theory of Coordination

- (Thomas Malone and Kevin Crowston, "The Interdisciplinary Study of Coordination", ACM Computing Survey, Vol 26, No 1, March 1994)
- Coordination Theory
  - coordination as managing dependencies among activities
  - dependencies among tasks
  - different sorts of dependencies
  - coordination processes to manage them
    - Shared Resources
    - Task Assignment
    - Producer / Consumer
- Many different sort of systems and organisations can be modelled as such

# Activity Theory (AT)

- (Vygotsky, "Mind in Society", Cambridge, 1978, Harvard University (Press))
- (Engestrom, "Activity theory and individual and social transformation. Opening address at 2nd International Congress for Research on Activity Theory, Lahti, Finland, May 25-25, 1990)
- (Bonnie Nardi, "Context and Consciousness", 1996, MIT Press)
- (Jakob Bardram, "Designing for the Dynamics of Cooperative Work Activities. In Proceedings of The 1998 ACM Conference on Computer Supported Cooperative Work , Seattle, Washington, USA. 1998, ACM Press)
- Theory about the development/dynamics of collective human work
  - Social/Psychological focus on human activities
    - objects and objectives
    - collaboration activities and actions
  - Focus on **activities** and **artifacts** which always mediate human activities
    - Both physical and psychological nature
      - cultural means, tools, signs mediating the relationship between human agent and objects of environment
    - Explicit account for contexts and situated interaction
    - Particular focus on social artifacts, mediating social activities



# CSCW and Workflow Management

- (Kjeld Schmidt, Liam Bannon. "Taking CSCW Seriously: Supporting Articulation of Work", International Journal of CSCW, 1(1):7-40, 1992)
- (K. Schmidt and C. Simone. "Coordination mechanisms: Towards a conceptual foundation of CSCW systems design". International Journal of Computer Supported Cooperative Work (CSCW), 5(2-3):155-200, 1996)
- **Coordination and articulation as main issues**
  - complex society/organisation context
- (K. Schmidt and C. Simone. "Mind the gap! towards a unified view of CSCW". In The Fourth International Conference on the Design of Cooperative Systems COOP 2000, May 2000)
- (U. Dayal, M. Hsu, and L. Rivka. "Business process coordination: State of the art, trends and open issues". In M. G. Apers, P. Atzeni, S. Ceri, S. Paraboschi, K. Ramamohanarao, and R. T. Snodgrass, editors, Proceedings of the 27th VLDB Conference, pages 3P13. Morgan Kaufmann, Sept. 2001)
- **Gap between flexibility and automatism/structure**
  - Hot discussion: Suchman vs. Winograd & co.
    - automated mechanisms / coordinators
      - Winograd & Flores, Workflow Management Approach,...
    - situated action
      - Suchman and classic CSCW
  - CSCW toward more coordination support from infrastructure
  - WfMS toward more flexibility for unpredictable events

# Remarks (2)

- The Lack of a Unitary View causes
  - Weak scientific debate
    - Separated clusters of coordination scientists
    - Fragmented results
  - Feeble spreading of relevant results
    - No impact on other communities
      - That may even need them...
    - Sporadic trans-disciplinarity
    - People re-invent the wheel
      - Microsoft Orchestration?
  - No transfer to industry
    - Unmarketable concepts and technologies
    - No impact, in the end
- Is “Unitary View” what we really need?

# Remarks (3)

- Complexity involves multiplicity, require a multiple views
  - avoiding the idea of finding THE view
  - multiplicity as intrinsic properties of complex systems
- Looking for a common frame, a structure, a sieve where the multiple views
  - (1) could be located, discussed, and compared in some of their parts
  - (2) could benefit one each other
    - beyond inter-disciplinarity, toward trans-disciplinarity
- Understanding and bridging coordination “gaps”

# Further Facts

- New people are not encouraged to face the issue
  - New students?
- Some popular journals start refusing to talk about coordination
  - “It is one of the key issues, but not perceived as such by our readers”
- This “science” is meant understanding and building complex systems
  - Not make it even more complex

# The Coordination Sieve

- Motivations
- The Whole Mess of Coordination
- The Coordination Sieve
  - Goals
  - 4 Layers
  - Vertically & Horizontally
- Framing Coordination with the Sieve
- Final Remarks

# Goals (1)

- Make it simpler
  - providing the right level of abstraction / separation
  - without sacrificing the perception of complexity
- Understand / interpret most relevant approaches and results
  - help other people understand
- Do not “unify” approaches and results
  - instead, put each of them in the right place
  - by interpreting them as different “views” on complexity
  - unified views typically attempt more than they can compass
  - exactly because there is nothing like a “unified view” for complex systems

# Goals (2)

- Make cross-fertilisation a solution, rather than a problem
  - the problem is not writing huge “Related papers” sections
    - cross-fertilisation is not “Yeah, I read that paper from the outside”
  - nor finding someone else asserting what I do not dare to say
    - cross-fertilisation is not “People from the outside told that, so...”
  - this issue already raised in many different places
    - Schmidt & Simone “Mind the Gap” (CSCW -> Workflow)
    - Mamei & Zambonelli Co-fields
    - Parunak’s Stigmergy coordination

# Goals (3)

- Provide people a tool (a frame)
  - Supporting both the scientist and the engineer
  - To understand and **compare** the different views on coordination
    - for instance, understand when a comparison makes sense
  - To exploit the benefits and pluses of the different views
  - Promoting cross-fertilisation
- Not labelling, but extracting
  - Different views should not be “labelled” and classified according to some Linneus-like hierarchy
  - They should instead be “sieved” trying to extract any useful notion, idea and contribution that could help
    - We frame their conceptual content, rather than the whole views



# The Coordination Sieve (1)

- A tool for
  - **Input a view** on coordination
    - Be it a model, a mechanism, a system, an application scenario, even a survey
  - Extracting / filtering out (**sifting**) whatever interesting / useful **content** ("seeds")
    - Both explicit and implicit content
  - Being careful not to forget the **context** altogether
- A **Multi-level** sieve
  - Contributions can come at different levels
    - Should be **sifted at different levels**
  - First check
    - If the sieve works, different "seeds" sifted at the same level by different views should be inherently **comparable**

# The Coordination Sieve (2)

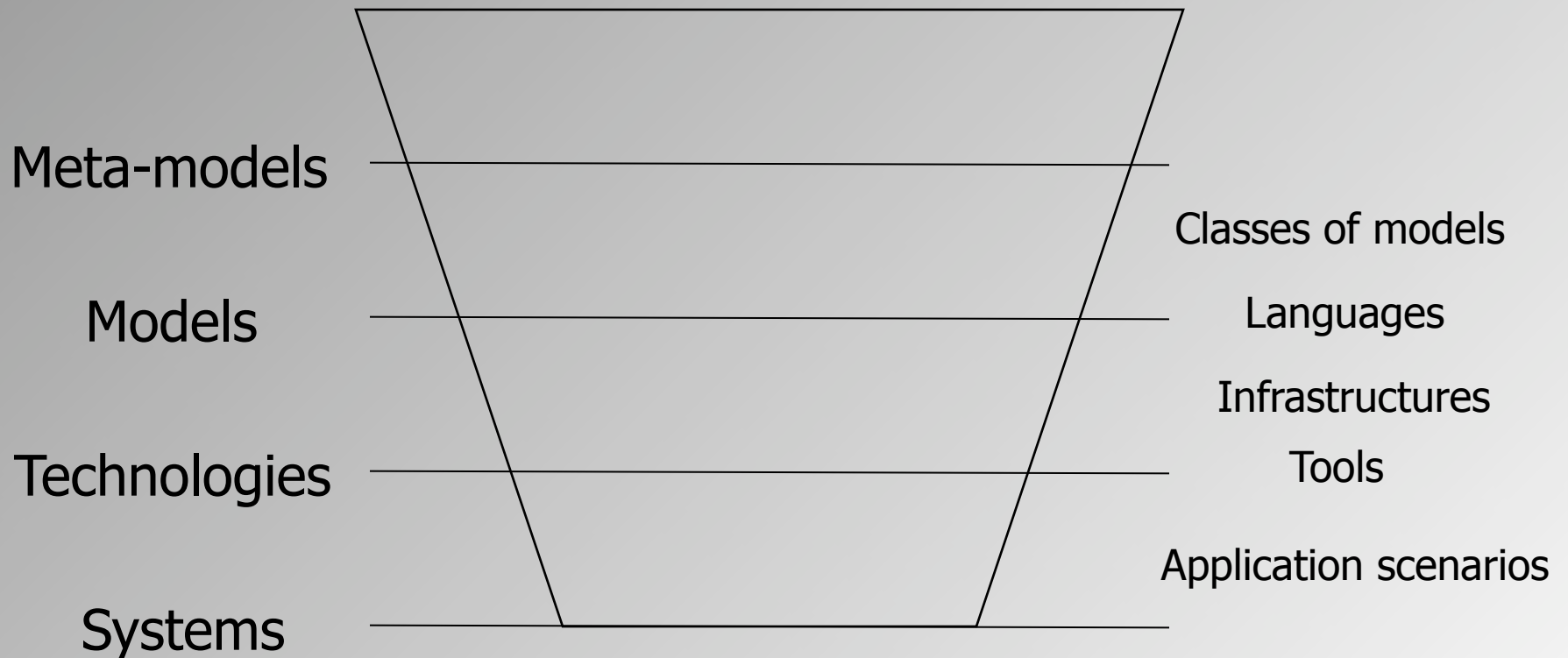

# Meta-models

- A meta-model provides a key to interpret / represent coordinated systems at a chosen level of abstraction
  - An ontology for coordination
    - either explicit or implicit
      - it might be a declared intent, or an unexpected result
    - either conceptual or pragmatic
      - a priori (construction) / a posteriori (observation)
- A meta-model defines the constructive / observable elements and the rules of construction / observation
  - Entities and classes of entities
    - Environment as what is relevant around the entities
  - Relationships and Patterns
    - among the entities
    - between entities and the environment

# Sifting a Meta-model

- Extracting the ontology
  - reported it, if explicit
  - assuming it, if implicit
- It should anyway come from “the inside”
  - not be a priori super-imposed
  - but rather understood from text & context
  - when unclear, better to say “unclear”
  - look for the **intrinsic** ontology
- Cross-fertilisation
  - should **not** come **before**
  - but after the discovery of the intrinsic ontology

# Models

- A set of conceptual and linguistic abstractions
  - enabling the representation / construction of coordinated systems
  - and the specification / engineering of coordination technologies
- Every model comes along with its own meta-model
  - the intrinsic meta-model
    - which should not be accounted for at this level
    - since it was sifted above
  - however, any other meta-model providing a useful interpretation of a model is “allowed” in principle
    - if it adds something to the general understanding of the model
    - sometimes, a different meta-model says more than the intrinsic one
- Often, coordination models are only partially specified
  - classes of models

# Sifting a Model

- A model of coordination is concerned with both the syntax and the semantics of architecture and interaction
- Syntax
  - how are entities represented, and their relations as well
  - which language do entities use to express themselves, and to act upon the environment
    - which is what we usually call coordination language
      - “linguistic reification of a coordination model”
  - ...
- Semantics
  - meaning of symbols
  - behaviours
  - issue of formal specification
    - of both syntax and semantics

# Technologies

- Reification of a coordination model / language
  - at development time
  - at run time
- Coming from
  - specifications
    - white papers
    - papers
    - manuals
    - requirements
    - formal specifications
  - hw / sw
    - API, packages, infrastructures, ...
    - source code / observable behaviours
    - development / deployment tools

# Sifting a Technology

- A technology embeds a model
  - either explicitly or implicitly
  - again, extracted above in the sieve
- and comes with a container
  - hw / sw
    - e.g., an infrastructure, or a wireless device
  - which should not be sifted away, or lost
- Requirements & Supplies
  - requirements define the boundaries / context for a technology
  - supplies define what a technology provides
    - to scientists, engineers, technicians, components, agents, ...



# Systems

- Individual systems
  - from a single application scenario, an ad hoc solution that embeds some (form of) coordination
    - intelligent heating (Gustavsson 1998)
- Classes of systems
  - from a common application scenario, with specific requirements and features, a (locally) general purpose approach to coordination
    - WfMS
    - CSCW
- Classes of problems
  - from conceptually wide application scenarios, sharing a few characteristic features, some complex coordination problems
    - pervasive / ubiquitous computing
    - ambient intelligence
    - ...

# Visiting / Traversing the Sieve

- Top-down (Vertically)
  - Decomposing (sifting) the aspects of an approach at the most suitable **level of abstraction**
    - Classifying the different contents, the “seeds”
  - Once decomposed, the aspects at the same level are ready for mapping and **comparison**
  - not (necessarily) a single label upon a single approach
- Horizontally
  - relating and comparing the seeds from different approaches
    - now homogeneous, at the same level of abstraction
      - comparable
  - enabling / promoting inter / trans-disciplinarity

# Framing Coordination with the Sieve

- Motivations
- The Whole Mess of Coordination
- The Coordination Sieve
- Framing Coordination with the Sieve
  - Sifting Meta-models
  - Sifting Models
  - Sifting Technologies
  - Sifting Systems
- Final Remarks

# The Sieve in Action: Extracting the Meta-models

- Sifting essentially means answering to some basic questions
- Examples of questions for extracting a meta-model
  - What is a system / a component in this approach?
  - How can we distinguish a system / a component within – ?
    - criteria a priori (construction) / a posteriori (observation)
  - When does a component belong to a system?
    - relation between system and components
  - How do components relate each other?
    - static, structural relationship
      - architecture
    - dynamic, behavioural relationship
      - interaction

# Sifting the Theory of Coordination

- Basic bricks (Ontology)
  - **Activity**
  - **Dependency**
    - “If there is no interdependency, there is nothing to coordinate”
  - Components?
    - no
    - entities in charge of activities are not addressed as first-class in the meta-model
- Managing dependencies between activities is a **Coordination Process**
  - coordination is fine grained
  - many different sorts of coordination processes
    - account for diversity in the coordination field

# Sifting the Theory of Coordination: Remarks

- What do we learn?
  - The process (or activity) of coordination involve two basic tasks
    1. detection of the dependencies
    2. decision respecting which coordination action to apply
  - A coordination mechanism shapes the way agents perform these tasks
  - Mainly a bottom-up approach
    - dependencies as starting point
- More generally, we learn that
  - Coordination can **abstract away** from the intrinsic nature of coordinated / coordinating entities
    - in fact, the meta-model has no requirements for them

# Sifting Activity Theory

- Context
  - Organisation Science
- Meta-model
  - activity
    - individual, social (collective)
  - artifacts
    - as the mediators of any interaction
    - as the results / goals / tools of any activity
  - relationships between individual activity and artifacts depend on the level of the social activity
    - co-ordination: artifacts are used by actors/activities
    - co-construction/co-operation: artifacts are engineered (ideated, designed, developed, mantained) by actor/activities

# Sifting Activity Theory: Remarks

- What do we learn?
  - the role of artifacts and mediated interaction
    - modelling / engineering social activity
    - focus on embodied artifacts
  - three distinct levels characterising collaborative work activities acting on or through artifacts
    - co-construction, co-operation, co-ordination
  - dynamics between the levels
    - inspecting and forging the artifacts
  - artifacts are subjects of engineering
    - design, development, deployment, maintenance, evolution...
  - top-down approach to coordination
    - the starting point is the social objective, that guides design and development of the artifacts
- Everything at the meta-model
  - no surprise



# Sifting Ciancarini '96

[ Paolo Ciancarini: Coordination Models and Languages as Software Integrators.  
ACM Computing Surveys 28 (2): 300-302 (1996) ]

- Context
  - SE perspective
  - Coordination models and languages in distributed systems
- Meta-model
  - coordinables
    - who participates to coordination
  - **coordination media**
    - abstraction enabling and ruling coordinables interactions
      - examples: semaphores, monitors, tuple spaces,..
  - coordination laws
    - defining the behaviour of the coordination medium with respect to coordinables actions
    - coordination language
      - primitives used by agents to act on the media
    - communication language
      - language used to describe information exchanged in the context of the coordination language

# Sifting Ciancarini '96: Remarks

- What do we learn?
  - Separation and **orthogonality** between
    - coordinated entities (coordinables)
      - focused on computation
    - coordinating entities (coordination media)
      - focused on (the management of the) interaction
  - Expressiveness
    - This meta-model is expressive enough to describe all the coordination models and languages emerged from the PL/DS/SE coordination community
  - Again, everything at the meta-model
    - again, no surprise: it was meant

# The Sieve Horizontally: Mapping at the Meta-level

- Mapping Activity Theory & Coordination Models
  - Actors vs. Coordinables
    - represent the individual tasks / activities
  - **Artifacts** vs. **Coordination Media**
    - represent the means to accomplish the social / global task
    - typically shared and used concurrently by multiple agents
    - providing agent a set of possible actions
    - enabling and constraining / governing agent interaction

# Trans-disciplinary Outcome: Coordination Artifacts for MAS

- Coordination media as artifacts in the MAS context
  - coordination artifact
- Three separate hierarchical levels for MAS coordination activity
  - co-ordination
    - enactment: using the coordination artifacts to achieve the objective
      - fluid and automated coordination
  - co-operation
    - establishing how to achieve the social tasks and goals
      - coordination rules and norms
    - designing and forging cooperatively the coordination artifacts
      - using the rules and norms for defining their behaviour
  - co-construction
    - establishing MAS objectives
      - social tasks, goals

# Coordination Artifacts: Dynamism between Levels

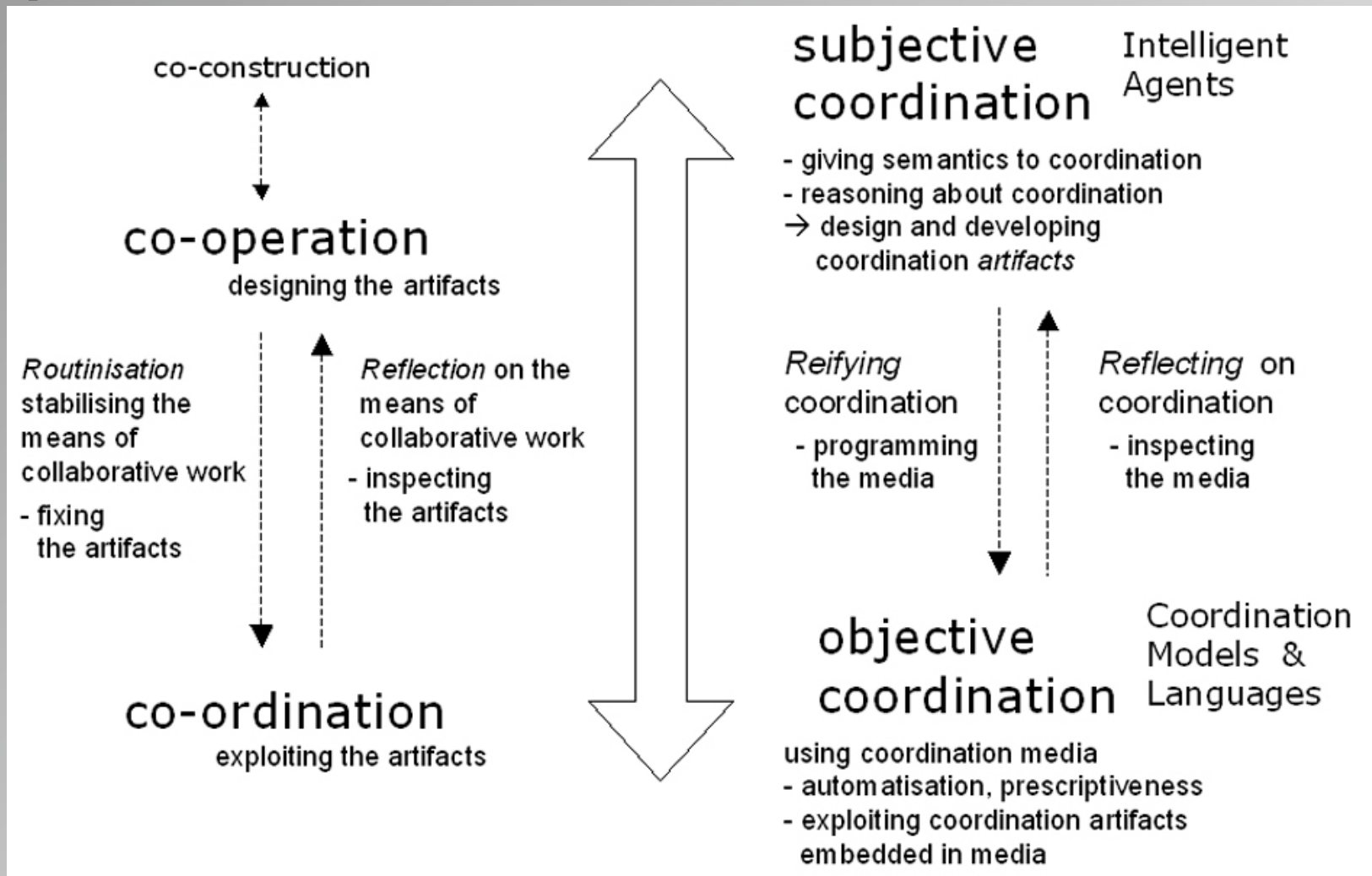

# Trans-disciplinarity:

## AOSE with Coordination Artifacts

- Conceptual premise
  - meta-models impact on methodologies
- Idea
  - how does the notion of coordination artifact impact on AOSE?
- Some results
  - promoting independent engineering of agents / artifacts
  - designing & development with coordinations artifacts
    - separation of coordination and computation from design stage
    - benefits
      - uncoupled design
      - reducing complexity
  - deployment with coordination artifacts
    - keeping abstractions alive
      - from design to development down to execution time
    - benefits
      - making debugging / change / evolution of coordination easier
      - enabling / promoting corrective/adaptive/evolutive system maintenance

# Sifting Linda: Meta-model Level

- (David Gelernter, Nicholas Carriero. "Coordination Languages and Their Significance". CACM 35 (2): 96-107, 1992)
- Basic bricks (Ontology)
  - there are active entities
    - performing admissible **coordination primitives**
  - there are **shared data spaces**
    - upon which coordination primitives are performed
  - **tuples** are exchanged between active entities and shared data spaces
    - tuple spaces
- Relationships
  - active entities can act on the shared data spaces by means of set of basic primitives (**coordination language**) using tuples
  - constraints also on the (inner) behaviour of the entities acting on the spaces according to the primitive invoked

# Sifting Linda: Model Level

- (David Gelernter, "Generative Communication in Linda", TOPLAS 7 (1): 80-112, 1985)
- **Generative Communication model**
  - communication survive to the emitter
    - tuples have an independent life in tuple spaces
- **Tuple spaces**
  - multi-bag/set of data objects/structures called tuples
- **Tuples**
  - ordered collection of (possibly heterogeneous) information items
- **Coordination primitives**
  - put/read/retrieve tuples to/from the tuple space
    - out, in, rd (,inp, rdp)
- **Coordination defined by the semantics of the primitives**
  - determined by the behavior of the tuple space in response to coordination primitives
  - coordinables synchronise, cooperate, compete based on tuples available in the tuple space, by associatively accessing, consuming and producing tuples



# Linda Model

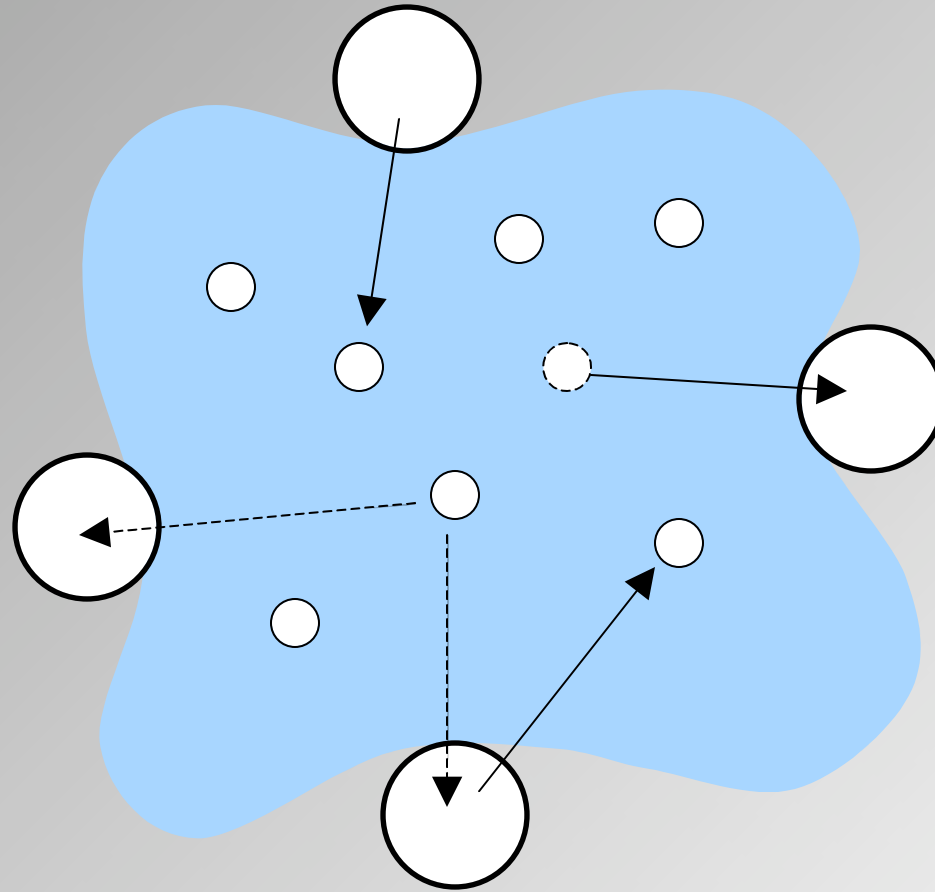

# Linda as a Coordination Model

- Obviously, Ciancarini '96 Meta-model perfectly applies to Linda
  - Coordination media
    - tuple spaces
  - Communication language
    - tuples
  - Coordination language
    - out, in, rd (,inp, rdp)
  - Coordination laws
    - semantics of the primitives + tuple space behaviour

# Sifting Linda: Remarks

- What do we learn?
  - and what is coordination for Linda, finally?
    - coordination as the activity reified by the exchange of tuples and the mechanisms and laws established ruling the access to the shared data spaces
    - no models specified / provided for the coordinables
      - but constraints on their observable behaviour on the tuple spaces
    - coordination is outside the agent
- Linda completely sifted with the meta-model and model level
  - not surprisingly
- ...and C-Linda? Or more generally Linda & its friends?
  - same (meta-)model of Linda, same class of model
    - that enables the consistent exploitation of the same coordination language with a multiplicity of computational languages
  - but sifting may not stop at the model level...

# Sifting JavaSpaces specification: Meta-Model & Model

- Context
  - Sun looking for the Distributed System silver bullet
- Same Linda meta-model
  - “Classical” coordination model
- Same Linda **class** of models
  - we may repeat the same slides with some search&replace
  - with some addition / specialisation
- Model peculiarity
  - communication language
    - Java Objects
  - coordination language
    - read, write, take
  - extensions
    - Events, Lease

# The sieve horizontally: JavaSpace and Linda

- Tuple-based family
  - Java Objects instead of tuples
  - but the role of the communication language does not change
- Same sort of coordination language
  - read, write, take instead of rd, out, in
  - but basically the same behaviour
- Extension
  - Lease
  - new granularity between in & inp (rd & rdp)

# Sifting JavaSpaces implementation

- It should be sieved as the JavaSpace specifications leaving the same information at the meta-model and model level...
- ...but should leave something also down to the technological level
- we will be back on the issue in few slides

# Sifting DAI Approaches: Meta-model Level

- Distributed problem solving
  - Basic bricks (Ontology)
    - **Tasks**
    - Autonomous problem solvers
  - Relationships & Interactions
    - **Inter-dependencies** among tasks
    - Task assigned to the problem solvers
  - Complex environments
    - multiple tasks, interaction, timing consideration, unpredictability

# Sifting DAI Approaches: Model Level

- Coordination analysis: TAEMS formal language
  - coordination problem representation
  - formal description of task structures and relationships
    - formal, quantitative, mathematical definition
    - annotated language on top of HTN (Hierarchical Task Network) plans (Durfee)
  - multiple levels for environment and task characteristics
    - generative, subjective, objective



# Sifting TAEMS, GPGP & co.:

## Model Level

- Coordination design: GPGP
  - domain independent scheduling
    - based on an idealized model of agents' activities (task structure) and coordination relationships abstractly defined
      - TAEMS to represent task structure and relationships
  - basic coordination mechanisms
    - communicating abstract and hierarchically organized information
    - detecting in a general way the coordination relationships needed by the partial global planning mechanisms
    - separating the process of coordination from local scheduling

# Remarks (1)

- Coordination as distributed problem solving
  - defining some kind of goal/task graph
    - identification and classification of dependencies
  - assigning regions of the graph to agents
  - controlling decisions about which areas of the graph to explore
  - traversing the graph
  - ensuring that successful traversal is reported

# Remarks (2)

- Complex closed environments
- Large-grain agents
  - high level symbolic capabilities
    - understanding task structures & planning
  - “heterogeneous intelligent” agents
    - dynamic, real-time, negotiating agents
      - Medium/low cardinality of agent societies
- Defining general purpose coordination mechanisms
  - toward engineering
    - reuse of coordination strategies and solutions
  - GPGP
    - distinction between coordination behaviour and local scheduling
      - modulating local control, not supplanting it
    - coordination patterns catalog

# The Sieve in Action: Comparisons

- TAEMS/GPGP meta-model and Theory of Coordination
  - managing dependencies among tasks
  - GPGP coordination patterns and coordination process handbook (MIT CCS)
- Comparing general purpose coordination mechanisms (expressiveness)
  - GPGP mechanisms
  - Coordination specification language (e.g. ReSpecT)
- Coordination reuse: patterns
  - GPGP coordination patterns
  - ReSpecT patterns
  - Coordination process handbook (MIT CCS)
  - Kendall's patterns

# Sifting Coordination Patterns

- (Dwight Duego, Michael Weiss, Elizabeth Kendall. "Reusable Patterns for Agent Coordination". In Coordination of Internet Agents, Omicini et al. eds., Springer Verlag, 2001)
- **Basic catalog**
  - Blackboard Pattern
  - Meeting Pattern
  - Market-Maker Pattern
  - Master-Slave Pattern
  - Negotiating Agents Pattern

# Sifting ACL Approaches: Meta-model Level

- Basic Bricks (Ontology)
  - Social entities with **communication** as the means for perception and action
    - speech act theory
- Relationships
  - Social entities interact through direct communication
    - sharing an ACL
      - syntax, semantics and pragmatics

# Sifting ACL Approaches: Model Level

- Conversation protocol
  - mechanisms for structuring agent interactions
    - prearranged task-oriented, shared sequences of messages that agents observe, in order to accomplish specific tasks
  - Basic conversation issues
    - specification
      - DFA, COOL, Colored Petri Net, ...
    - sharing
    - aggregation
  - Formal verification of coordination properties
    - reachability, boundness, home properties, liveness, fairness

# Remarks

- Coordination purely on top of communication
  - beyond the knowledge sharing approach (interoperability)
  - basic hypothesis: coordination as a purely communicative issues
  - direct communication
    - strong temporal/spatial coupling
- Approaches aiming at open/dynamic societies and heterogeneous agents
  - Not so open, actually
    - large-grain intelligent agents
    - societies with medium-low cardinality
- Marginal role of the environment



# The Sieve in Action: Comparisons and Trans-disciplinarity

- From ACL meta-model to Activity Theory (AT) and back
  - Conversation and interaction protocols as AT artifacts
  - Feedbacks from AT studies
    - conversations good for suitable for low/medium-complexity coordination
      - complex coordination calls for more uncoupled form than direct communication
    - how to enforce agents to follow conversations?
- From ACL meta-model to Theory of Coordination and back
  - Capturing dependencies only by means of the ACL
  - ACL Conversations and basic coordination patterns

# Sifting Well-known Jennings' Definition...

- [Reminder]: Coordination as the process by which agents reason about their local actions and the (anticipated) actions of the others in order to ensure that all agents in a community act in a coherent manner towards a goal or a set of goals... The actions of multiple agents need to be coordinated because of dependencies between agents' actions, the need to meet global constraints, and no one agent has sufficient competence, resource or information to achieve such system goal.
- **Meta-model**
  - same as DAI-approaches
  - entities able to observe and reason about local actions and their effect on the environment
  - relationships/interaction:
    - sharing goal(s)
    - dependencies among their actions

# Remarks

- Coordination burden totally on agents
  - coordination uniquely based on individuals capability of observing, interpreting/reasoning, and acting upon the environment
  - no mediators for agent (inter)action

# Sifting Market-based Approaches: Meta-model Level

- Market (artificial economy)
  - Basic Bricks (Ontology)
    - goods
      - environment resources
    - agents
      - self-interested rational decision makers
  - Relationships/interactions
    - agents as producers and consumers of the goods
    - Theory of General Equilibrium
      - distributed planning systems based on priced mechanisms

# Sifting Market-based Approaches: Model Level

- Model
  - Contract Net Protocol(s)
  - Market-Oriented Programming
    - basic mechanisms implementing various sorts of agents, auctions and bidding protocols
    - describing computational economy (market configuration)
      - definition of a set of goods
      - instantiation of a set of producers and consumers
    - computing the competitive equilibrium of the economy

# Remarks

- Casting every coordination context as a market
  - es: distributed planning problem
    - goods traded + agents trading + agents bidding behaviour
- Open societies
  - heterogeneity
  - dynamism
  - high cardinality

# The Sieve in Action: Comparisons

- Market meta-model vs. (Theory of coordination, Ciancarini's and AT)
  - producers/consumers as specific kind of dependencies
  - Theory of General Equilibrium as the coordination laws managing these dependencies
    - basic hypothesis on agents
      - rational, competitive behaviour, small with respect to overall economy
  - Auctions and bidding protocols as 'disembodied' artifacts
- Basic issues (about coordination expressiveness):
  - All the dependencies in terms of competitive producers/consumers dependencies?
  - General purpose coordination artifacts based on the Theory of General Equilibrium?

# The Sieve horizontally: Who/where is the Coordinator, finally? (1)

- Meta-model level
  - two different approaches (at least)
- Ciancarini '96
  - coordination is charged upon the coordination medium
  - coordination outside the agents
  - agents are the coordinated entities (coordinables)
- Coordination Theory
  - dependencies are detected 'outside' the agents, but managed by coordination processes enacted by the agents themselves
  - coordination modelled outside agents, enacted by agents



# The Sieve horizontally: Who/where is the Coordinator, finally? (2)

- Model level
  - two different approaches (at least)
- Linda/JavaSpace
  - basic coordination is charged upon the tuple spaces
  - coordination outside the agents
  - but articulated coordination activities require agents to compose the basic coordination capabilities provided by the tuple spaces and the Linda coordination language...
    - coordination not fully encapsulated outside agents
    - limited expressiveness charge coordination load upon agents
- Jennings approach
  - coordination charged upon agents, possibly sharing conventions and interaction protocols
  - agents as coordinating entities

# Objective vs. Subjective Coordination

[ “Objective versus Subjective Coordination in the Engineering of Agent Systems” Omicini, Ossowski. In Intelligent Information Agents: The AgentLink Perspective. LNAI 2586 (State-of-the-Art Survey). Springer-Verlag , March 2003 ]

- Hot issue
  - affects every level of the sieve
  - affects modeling and engineering of systems
- Objective Coordination
  - coordination outside the agents
  - designer’s viewpoint over MAS
- Subjective Coordination
  - coordination from inside the agents
  - agent’s viewpoint over MAS

# Gap between Objective and Subjective Coordination

- Historically
  - two different, separate approaches
  - have not worked together / not even recognised each other
- However, no way to model / build complex (agent) systems adopting only one of the two viewpoints
  - need to reconcile / use them altogether
  - in both the modelling and engineering of MAS
- Activity Theory as a unifying meta-model
  - reconciling the two approaches around the notion of artifact

# Bridging the Gap: Activity Theory for Meta-models

- Approaches identified at separate AT levels
  - Objective coordination at the co-ordination level
    - coordination charged upon artifacts, whose behaviour reify the coordination laws, social rules and norms required to achieve the objective
  - Subjective coordination at the co-operation level
    - actors negotiate and establish cooperatively the coordination laws, social rules and norms required to achieve the objective, established at the co-construction level
- Level dynamism to bridge the gap
  - from co-operation to co-ordination = from subjective to objective
    - forging the artifacts with the designed coordinating behaviour
  - from co-ordination to co-operation = from objective to subjective
    - re-considering artifacts behaviour, to change/adapt coordination activities (es: facing coordination breakdowns...)

# Activity Theory for Meta-models

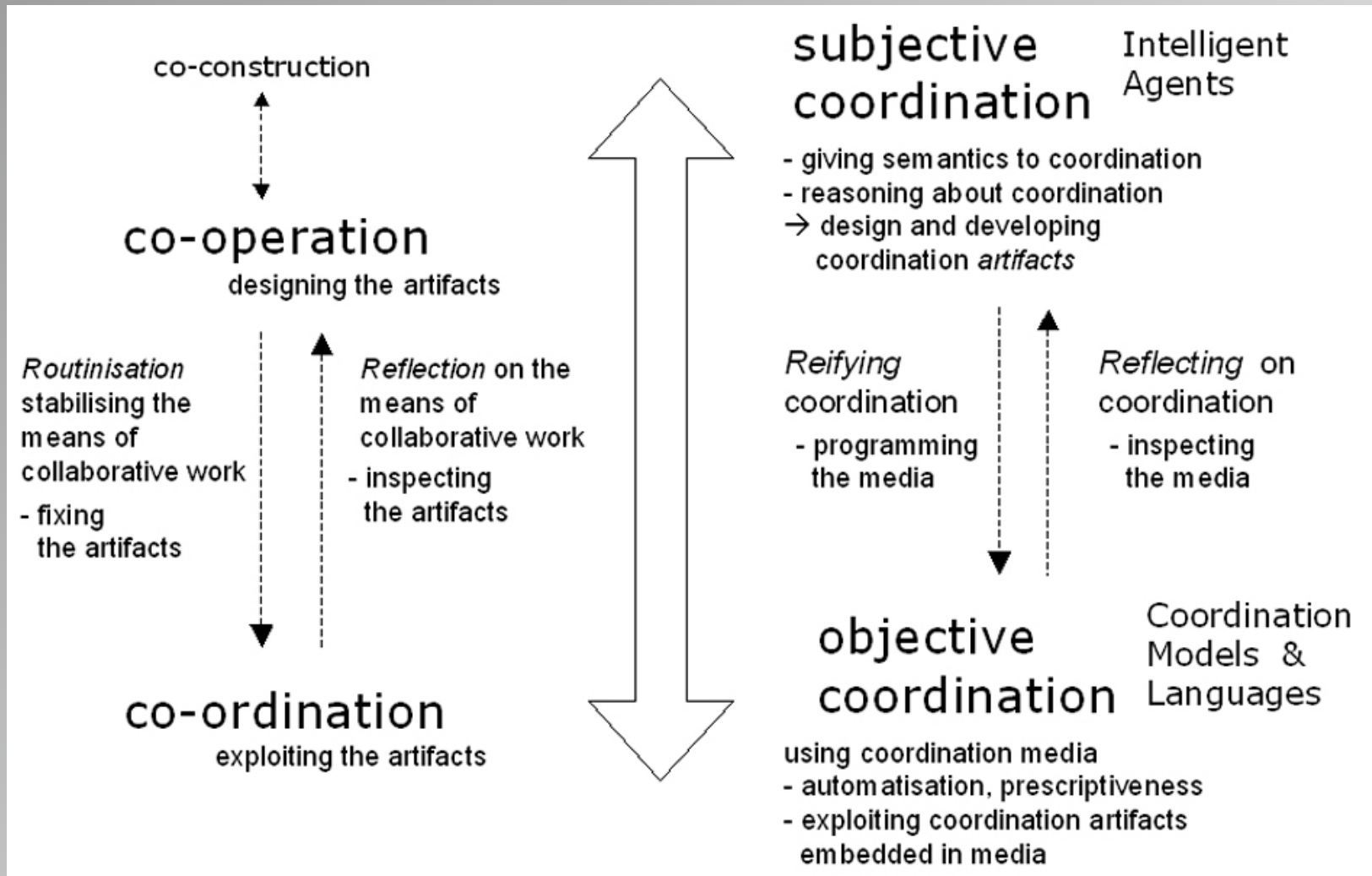

# Models bridging the Gap: TuCSoN

- TuCSoN coordination model aims at reconciling the subjective and objective point of view...

# Sifting TuCSoN: Meta-model Level (1)

- Basic bricks (Ontology)
  - there are autonomous and situated entities
    - situated in organisational contexts providing coordination services
    - entering and using the **coordination primitives** provided by the coordination contexts
  - there are shared general purpose customisable **coordination services** (as shared **programmable** data spaces)
    - distribute/collected in nodes of some organisational contexts
    - upon which coordination primitives are performed
  - **an coordination contexts** model entities presence inside an organisational context
    - allowed/forbidden actions/perceptions (coordination primitives)
  - **tuples** are exchanged between the autonomous entities and the coordination services
    - tuple centres

# Sifting TuCSoN: Meta-model Level (2)

- Relationships
  - the autonomous entities negotiate and enter coordination contexts in order to access and use the coordination services of an organisation
  - access and use of the services is provided by means of a set of basic primitives (**coordination language**) using tuples
    - using tuple centres (services)
    - inspecting/changing the behaviour of tuple centres (services)



# Sifting TuCSoN: Model Level (1)

- TuCSoN organisation/coordination space
  - organisation contexts characterised by distributed set of **nodes** providing tuple centres as coordination services
- Tuple centres as runtime coordination abstractions
  - logic **programmable** tuple spaces
    - logic tuples as communication language
    - ReSpecT for behaviour specification
      - formal semantics
  - general purpose customisable coordination services
    - coordination defined by the semantics of the primitives + the programmed behaviour of the tuple centre
    - behaviour can be inspected/changed dynamically

# Sifting TuCSoN: Model Level (2)

- (Mobile) agents join an organisation context by negotiating and entering an **agent coordination context**
  - enables and rules agents access to tuple centres according to their organisation position
    - coordination primitives for accessing/using tuple centres
      - out, in, rd, rdp, inp
    - coordination primitives for inspecting/changing tuple centres behaviour
      - set\_spec, get\_spec

# Remarks

- Extending Linda model
  - toward MAS
    - agent autonomy
  - **coordination as a service** philosophy
    - services encapsulating coordination
    - provided by the infrastructure
  - coordination + organisation
    - security

# The Sieve in Action: Bridging the Objective/Subjective Gap

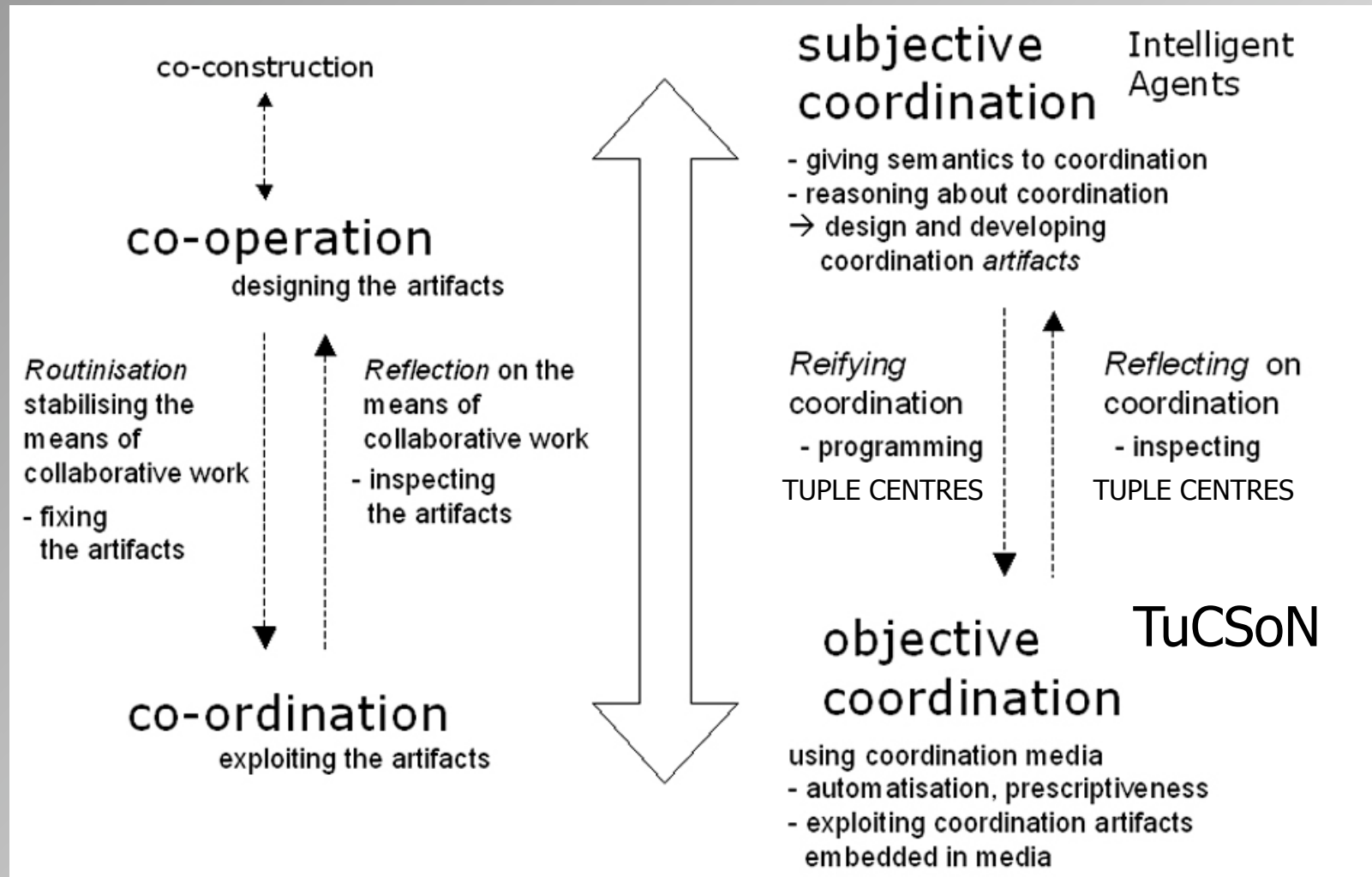

# Sifting TuCSoN: Technology Level (1)

- The infrastructure
  - Java-based
  - supporting heterogeneous agent models
    - currently Java and Prolog based agents
- Java API
  - Services
    - to negotiate and enter an agent coordination context
    - to act on tuple centres by means of the action enabled by the agent coordination context
  - Enabling java-based implementation of agent models to exploit TuCSoN coordination services

# Sifting TuCSoN: Technology Level (2)

- Tools
  - runtime support to development, deployment, monitoring and evolution of coordination artifacts
  - not only an implementation feature, but integrated part of the model/infrastructure
  - Tools for humans
    - Shell
      - to (inter-)act directly on tuple centres
    - Inspector
      - to inspect and debug at runtime the communication and coordination state of the tuple centre (coordination artifacts)
        - » inspecting and changing the behaviour of tuple centres by inspecting / changing the ReSpecT specification tuple set
    - NodeAdmin (soon available)
      - to manage the coordination resources of a TuCSoN node
    - OrgAdmin (soon available)
      - to manage the organisation issues of a TuCSoN organisation context

# The Sieve Up and Down: Remarks (1)

- The sieve supports both top-down and bottom-up analysis
  - from models to technologies, and vice-versa
- Bottom-up path issues
  - What is the (or a) model for a specific technology?
    - es: What is the model of JavaSpace technology? What is the model of C-Linda? What is the model of TeamCORE or DECAF?
  - Has the model a formal specification?
- Top-down path issues
  - How to build a compliant technology given the model/specification?
  - How to verify compliance?

# The Sieve Up and Down: Remarks (2)

- Lack of formal semantics for describing model behaviour can lead to distinct implementations with different behaviour and expressiveness
  - Example: Linda
    - born with no formal semantics
    - going bottom-up from different implementations (C-Linda, JavaSpaces, ...) --> different coordination behaviour
- From technologies to models: discovering inconsistency and holes
  - Example: Extracting the model from JavaSpaces technology
    - does not coincide with the JavaSpaces specification



# Sifting JavaSpaces Technology

- Reference implementation
  - from Sun
- Requirements
  - Java / J2EE
  - Jini
- Provisions
  - JavaSpaces as coordination media provided as coordination services
  - Event model
  - Lease model
- Industrial implementation available: GigaSpace
  - Provisions
    - Quality of service
      - Persistency, fault tolerance, scalability, performance, ...
-

# Hot issue: Expressiveness

- Historically emerged from considering/comparing technologies, but concerns models and meta-models
  - studied in particular in the context of objective models
  - impacting on all the other bottom levels
  - involving both interaction and computation
- Issues
  - At the meta-model level
    - What kind of relationships between the entities and the entities and the environment can be captured and specified?
  - At the model
    - What kind of coordination activities can be specified and enacted using a specific coordination model?
    - What kind of coordination activities, social tasks, ... can be supported by the coordination medium?
    - What kind of dependencies can be specified and managed?
    - What kind of objectives can be supported using some artifacts?

# Sifting Tambe's Teamcore: Model Level

- Teamcore model
  - providing each heterogeneous agent a **proxy** capable of general teamwork capabilities
    - Teamcore proxy
      - STEAM module, based on SOAR (Newel)
        - » reusable and general purpose teamwork capabilities
        - » automatically dealing with failures and contingencies
    - proxies automatically generate required coordination actions in executing their tasks and interact accordingly
  - Team-oriented programming
    - specification of
      - team organisation hierarchy
        - » role and groups
      - hierarchy of reactive plans
  - KARMA agents
    - locating agents and allocating roles/tasks

# Sifting Tambe's Teamcore: Technology Level

(David Pynadath and Milind Tambe, "An automated teamwork infrastructure for heterogeneous software agents and humans Journal of Autonomous Agents and Multiagent Systems (JAAMAS), 2002)

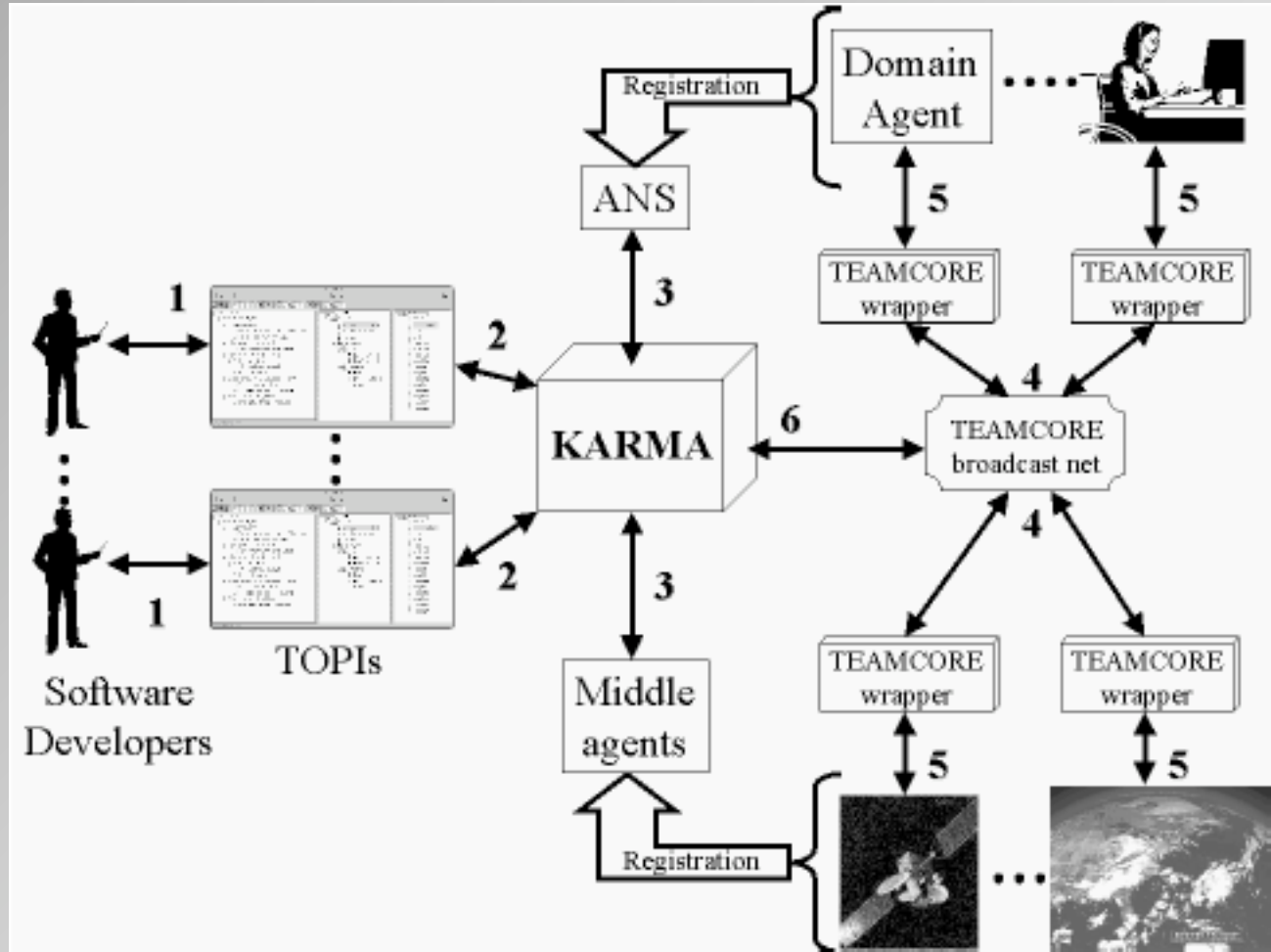
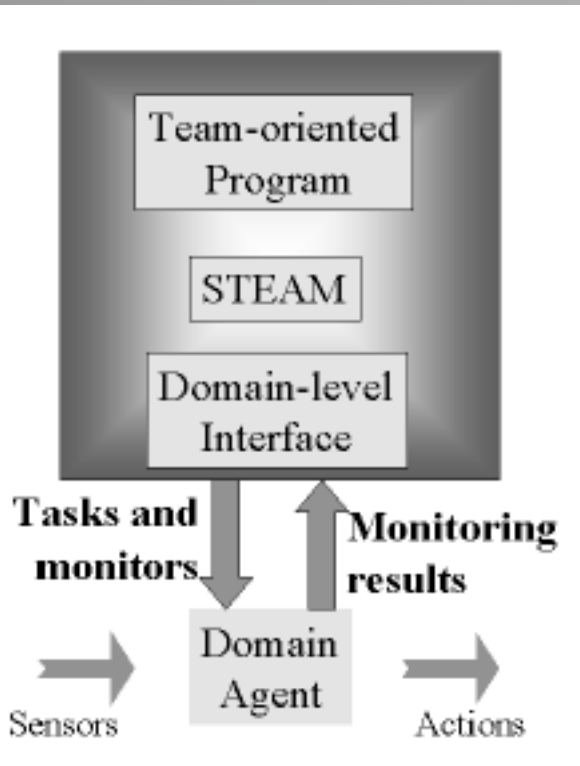

# Sifting Tambe's Teamcore: Extracting a Meta-Model

- Teams
  - Basic bricks (Ontology)
    - heterogeneous cooperative autonomous and situated entities
      - **no coordination capabilities**
      - shared goals
    - entities (proxies) with coordination capabilities
      - one for each autonomous entities
    - dynamic and unpredictable environment
  - Relationships
    - the proxies mediate agent interactions and generate suitable communication actions according to a global plan specification
      - SharedPlan theory (Grosz, Kraus)
      - Joint Intention Theory (Cohen, Levesque)

# Remarks

- Mediated interaction approach
  - Teamcore proxy mediating agent (inter)action
- Coordination burden outside the participant agents
  - Separation computation and coordination issues
  - support for heterogeneous agents
  - support for dynamically adaptation of coordination
- Encapsulation of coordination
  - reuse

# The Sieve in Action: Comparisons

- Questions
  - if every thing is an agent, what is a proxy, from a philosophical/meta-model point of view?
  - what are the relationships between an agent and his proxy?
- Answers from AT and Ciancarini's meta-model:
  - Teamcore proxies as coordination media/artifacts
    - Team-oriented programming language as behaviour specification language of the artifacts

# Sifting RETSINA Middle-Agents

- Basic Bricks (Ontology) and relationships
  - Entities providing/requesting services
  - Entities acting as mediation services
  - **Mediation services** manage dependencies among requesters and providers
- Model
  - Middle-agents acting as **mediators**
  - Predefined interaction protocols
    - matchmaking
    - brokering
    - arbitration in negotiation
- Technology
  - RETSINA infrastructure



# The Sieve in Action: Comparison

- Coordination as mediated interaction: Two basic flavors
  - using special agents as artifacts
    - ex: middle-agents and RETSINA
    - Distributed Cognition Theory
    - “Everything is an agent” motto
  - using coordination artifacts as first class citizens
    - ex: tuple centres and TuCSoN
    - Activity Theory
    - “Keep the abstractions alive” motto

# The Sieve in Action: Trans-disciplinarity

- From (mediation services/coordination artifacts) to (Activity Theory, CSCW meta-model) and back
- Properties of a coordination/mediation artifacts
  - predictability
    - formal semantics of artifact behaviour
  - inspectability
    - monitoring and tracking social history
  - dynamic 'forgeability'
    - evolution and adaptation of coordination
  - verifiability and 'debug-modality'
    - easy maintenance
  - robustness and quality of service
    - as part of the infrastructure

# Back to TAEMS, GPGP & co: Technology Level

- DECAF (Distributed Environment-Centered Agent Framework)
  - agent toolkit
    - RETSINA as basic infrastructure
      - design, develop, and execute agents
    - TAEMS and GPGP as models for representing/enacting coordination
  - large-grained intelligent agents
    - communication, planning, scheduling, execution monitoring, and coordination

# Sifting e-Institutions: Meta-model Level

- MAS as a society with norms
  - Basic Bricks (Ontology)
    - heterogeneous social agents
    - **Institution**
  - Relationships/interactions
    - Institutions enable and regulate agents (inter)actions
      - social **norms** and conventions
    - society goals through social order and control

# Sifting e-Institutions: Model Level

- e-Institutions coordination mechanisms and structures
  - define the social goals and related co-ordination structures
    - markets / network / hierarchy
    - roles (“what you can do”)
    - social norms
  - define exchange mechanisms of the agent society
  - enforce interaction and communication forms within the society
  - enable perception of the individual agents of the aims and norms of the society
  - services for **trust**
- e-Institutions coordination enactment model
  - setting up and running the societies
    - scenes (“where you can do it”)
    - protocols (“what can you say”)

# Remarks

- Strong relationships and synergy between organisation and coordination
  - security/trust issues
- Open societies
  - impossibility of embedding organisational/normative elements within agents
  - need to represent elements out of the agents, objectively
- Challenges and difficulties
  - Infrastructures? Tools?
  - from formal models to ‘first class abstractions’
    - social norms out of the agents, ok, but where?
    - how or where to embody Institutions, really?
      - middle-agents?
    - how or what (un)couple agents and Institutions?

# The Sieve in Action: Comparisons and Trans-disciplinarity

- Meta-model
  - Institution as coordination medium/artifact
    - enabling and ruling agent interactions
    - social norms and conventions as coordination laws
    - providing/ensuring security services (trust...)
- Model
  - ‘How/where to embed social norms and conventions?’
    - Middle-agents as mediator services of the e-Institutions
    - coordination artifacts as embodied artifacts e-Institution
      - e.g. TuCSoN tuple centres
    - agent coordination context concept to (un)couple agents and Institutions
      - e.g. TuCSoN agent coordination context
- Technology
  - Institution infrastructures supporting (coordination) artifacts as first class abstractions, used and accessed by agents

# Sifting Stigmergy Coordination: Meta-model Level

- Basic Bricks (Ontology)
  - autonomous active entities
    - heterogeneous
      - typically mobile, with no symbolic reasoning capabilities
    - capable to act and sense the environment by placing/sensing some kind of **sign**
  - **environment**
    - alive
      - collecting, transforming, producing signs
- Relationships
  - entities interact by placing and sensing signs on/from the environment
    - **local** interaction
    - mediated interaction



# Remarks

- Coordination as mediated interaction through the environment
  - openness and heterogeneity of the population
    - no need of complex communication languages
  - dynamism
    - evolution of organisation and coordination
    - self-organisation
  - prescriptive coordination
    - embedding domain constraints in the environment
  - quality of the coordination process
    - thermodynamics-like properties

# Sifting Stigmergy Coordination: Model Level

- **Pheromone**-based model
  - autonomous and mobile agents (like ants)
  - pheromones as signs
  - actions for deposit/sensing pheromones
  - environment coordination mechanisms
    - pheromones aggregation
    - pheromones evaporation
    - pheromones diffusion

# The Sieve in Action: Comparisons

- Describing pheromone-based model with Ciancarini's meta-model
  - autonomous entities as coordinables
  - environment (collection of places) as coordination medium
    - pheromone structures as communication language
    - services for deposit/sensing pheromones as coordination language
  - environment processes as coordination laws
- Comparisons: TuCSoN
  - TuCSoN nodes as environment places
  - tuple centres embodying environment function at each place
    - environment functions realised by tuple center behaviour
    - pheromones as logic tuples

# The Sieve in Action: Trans-disciplinarity

- ReSpecT vs. pheromone environment basic functions
  - expressiveness of coordination
    - which kind of coordination activities can be specified
  - are (aggregation/evaporation/diffusion) enough for describing and enacting any coordination activity?
  - what kind of ReSpecT patterns correspond to these services?

# Sifting Stigmergy Coordination: Technology

- (S. Brueckner. "Return from the Ant: Synthetic Ecosystem for Manufacturing Control". Thesis at Humboldt University of Berlin, Department of Computer Science, 2000)
- Pheromone-based agent infrastructure
  - network of places
    - agent mobility
  - place services (for agents)
    - deposit pheromones
    - query pheromones strength
  -

# Systems

- Individual systems
  - from a single application scenario, an ad hoc solution that embeds some coordination
    - intelligent heating (Gustavsson 1999)
- Classes of systems
  - from a common application scenario, with specific requirements and features, a (locally) general purpose approach to coordination
    - WfMS
    - CSCW
- Classes of problems
  - from conceptually wide application scenarios, sharing a few characteristic features, some complex coordination problems
    - pervasive / ubiquitous computing
    - ambient intelligence
    - ...

# Sifting CSCW: ABACO

(Divitini, M., C. Simone, and K. Schmidt, "ABACO: Coordination mechanisms in a multi-agent perspective," in COOP '96. Second International Conference on the Design of Cooperative Systems, Antibes-Juan-les-Pins, France, 12 - 14 June, 1996, INRIA Sophia Antipolis, France, 1996, pp. 103-122)

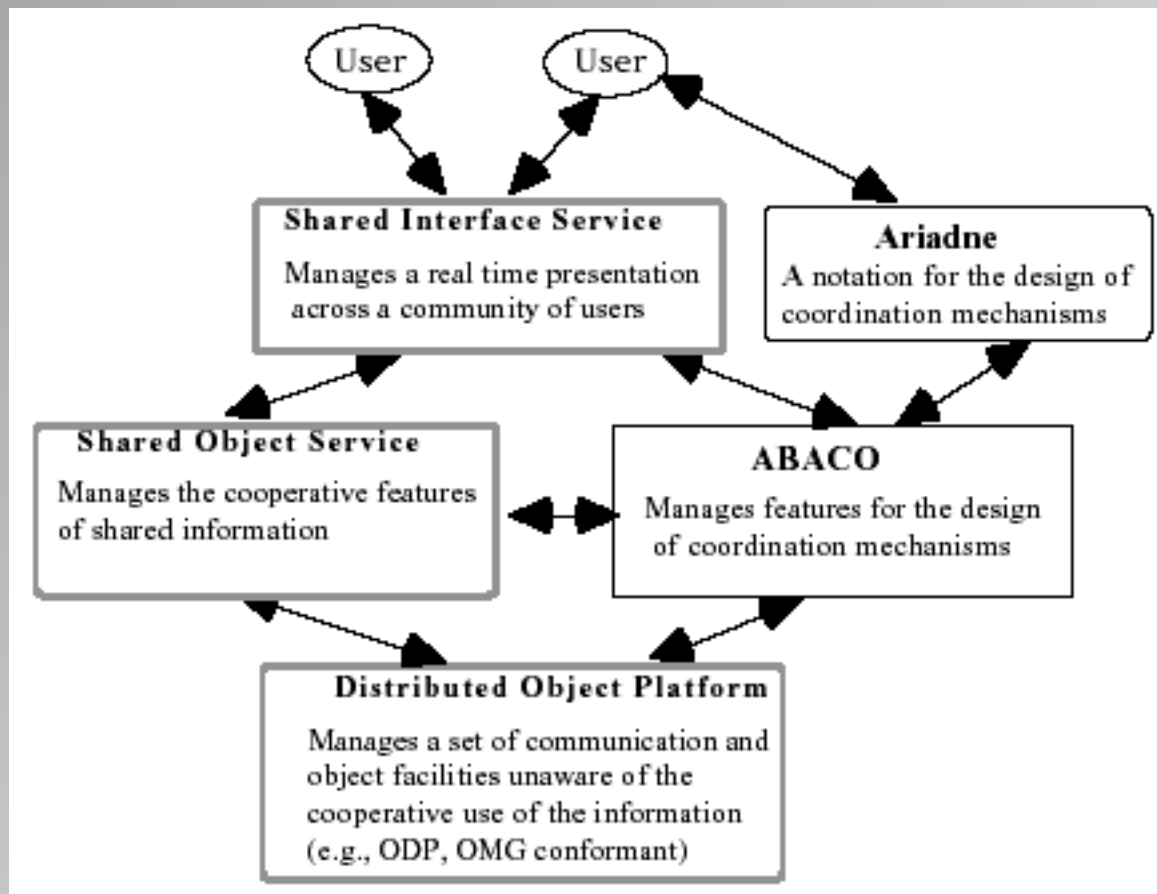

# Sifting ABACO: Technology Level

- Technology Level
  - ABACO (Agent Based Architecture for COordination mechanism)
  - multilayered agent based architecture
    - runtime creation, **composition** of active **computational coordination mechanisms (C<sub>2</sub>M)**
      - ARIADNE framework
    - each C<sub>2</sub>M as a composed agent
      - UI agents, Proctor agents, Active Artifact agents
    - Interoperability Language for agent interaction
      - inside and across multiple C<sub>2</sub>M agents



# Sifting ABACO: Model Level

- Model Level
  - Computational Coordination Mechanisms (C<sub>2</sub>M)
    - software device embedding artifact + protocols of a coordination mechanism
      - state / behaviour
    - dynamic composition and adaptation
      - Subscription, Inscription, Prescription functioning mode
  - Ariadne Language
    - General notation to build C<sub>2</sub>M composing basic Object of Articulation Works Components (OAW)
      - Role, Actor, Task, Activity, Action, Interaction, Resource

# Sifting ABACO: Extracting a Meta-model

- Meta-model level
  - Basic Bricks (Ontology)
    - multiple actors
    - common field of work
    - shared computational coordination mechanisms
      - coordinative protocols + artifacts (their objectifications)
  - Relationships and interactions
    - actors interact (work together) by changing the state of the common field of work through the access and use of the shared computational coordination mechanisms

# Remarks (1)

- Social nature of work
  - mutual dependencies in work require cooperation
    - positive inter-dependency notion
      - beyond the classic concept of dependency
- Coordination burden charged out of actors, upon computational coordination mechanisms
  - embodied entities
    - objectifying coordination protocols + artifacts
  - properties
    - **malleability**
    - linkability

# Remarks (2)

- **Articulation** of work
  - coordination activities + activities for
    - setup/shutdown of the coordination activities
    - rearrange/adaptation of the coordination activities
  - **mutual awareness**
    - supporting context observation
    - dynamic selection of the appropriate coordination mechanisms
  - interoperability among coordination mechanisms
    - mutual alignment of their boundary objects and events

# The Sieve in Action: Comparisons

- At the meta-model level
  - CSCW computational coordination mechanisms, Activity theory artifacts and Ciancarini's coordination media
    - objective coordination
      - coordination by means of mediating and ruling agent interaction
- Basic questions (trans-disciplinarity issues):
  - What about CSCW Articulation concept in MAS objective/subject approaches?
  - Can be the CSCW empirical research on computation coordination mechanisms useful also for MAS models?
    - Objective approaches
      - valuable indication for coordination artifacts engineering properties
        - » inspectability, predictability, ...
    - And for subjective approaches?
      - coordination artifacts for team-oriented programming?
      - coordination artifacts for reconciling distributed planning & execution?

# Sifting a system: a MAS-based Smart Home Services

- (Rune Gustavsson, "Agents with Power", [CACM 42](#) (3): 41-47, 1999)
- MAS for intelligent heating control in a smart environment context

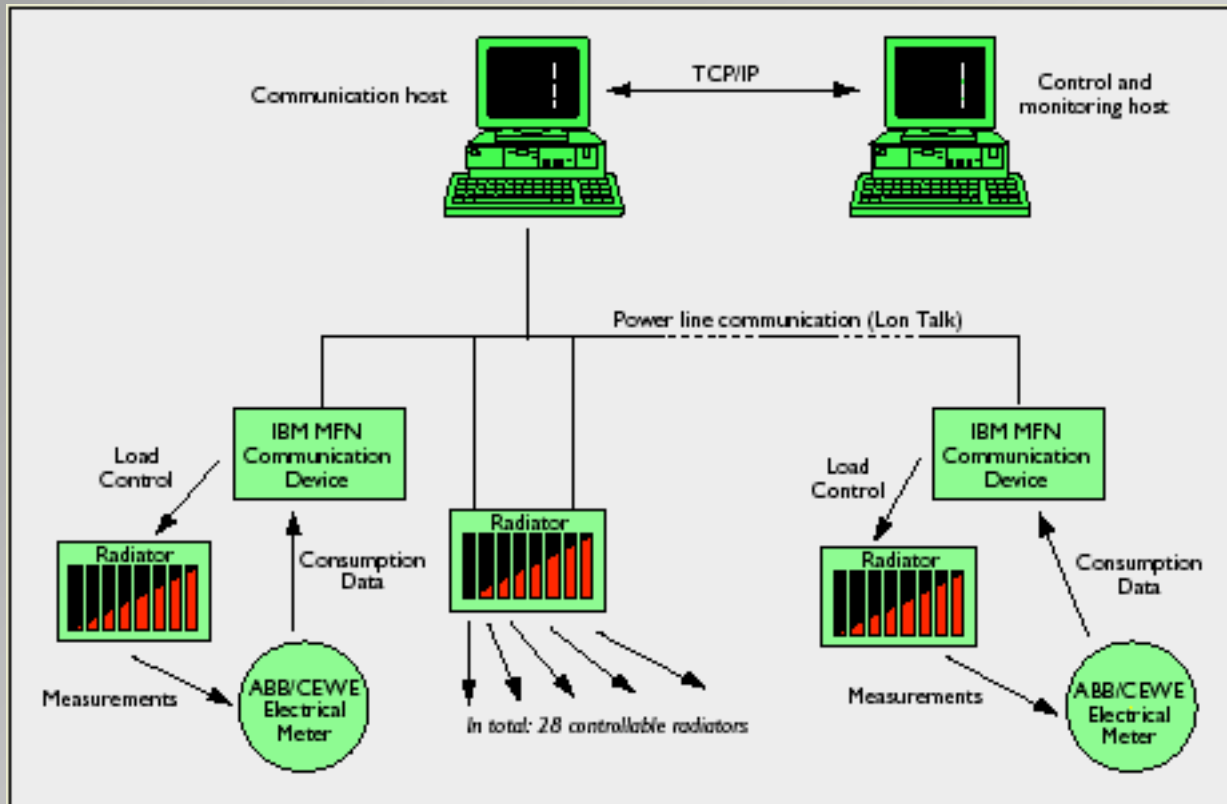

Villa Wega smart environment context (Ronneby, Sweden).

# Conceptual Structure of the MAS

- Interaction enabled by a LonWorks-based infrastructure
  - Enabling devices (sensors, actuators) exchange of information
  - State-table for storing tracking state of the environment
    - receiving and tracking all the information from devices

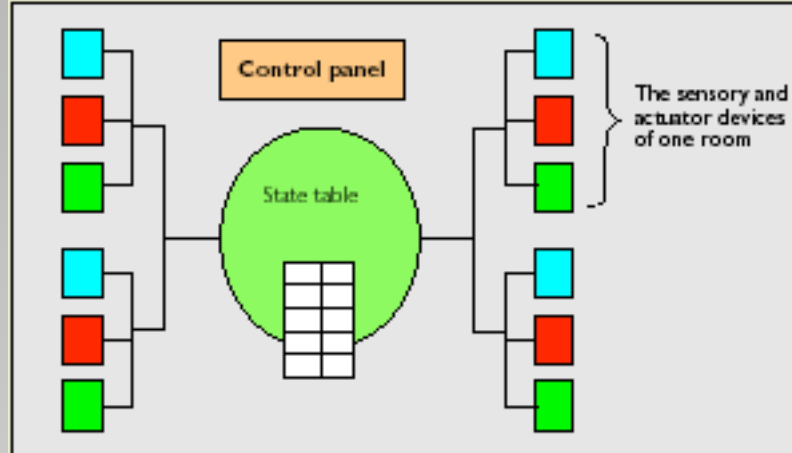

# The Sieve in Action: Extracting a Model

- Devices as coordinable entities
  - manifest their state
  - dynamic addition to/remotion from the system
- Shared state table as the coordination medium
  - tracking consistently the global state of the environment
  - inspectable



# Final Remarks

- Motivations
- The Whole Mess of Coordination
- The Coordination Sieve
- Framing Coordination with the Sieve
- **Final Remarks**
  - Lessons learned
  - Expected impact on MAS
  - Essential literature

# Lessons Learned (1)

- Each view / approach over coordination
  - was conceived in a context where it worked
    - given certain pre-conditions, it solved problems
  - provided certain features
    - at different levels of abstractions
    - comparison can be made only at the same level
- Complex systems present multi-level, multi-faceted problems
  - there is no tool to solve every problem
  - the point is not only to have all the tools available
    - in particular when so many tools are available
  - the problem is to understand which tool and when
    - and how to make them work together

# Lessons Learned (2)

- Different views on coordination as a multiplicity of sources
  - of ways to understand problems / systems
  - of conceptual tools to solve problems
  - in the modelling / engineering of complex systems
- to be used altogether whenever needed / useful
  - the Coordination Sieve could be a useful tool to help selection

# Expected Impact on MAS

- Modelling
  - Meta-models providing multiple, original viewpoints to interpret observations
    - conceptual tools for understanding / modelling complex systems
  - Multi-level, multi-source abstractions
    - cross-fertilisation
      - inter-disciplinary / trans-disciplinary
    - more articulated models
      - well-founded via media between simplicity and expressiveness
- Engineering
  - Meta-models providing multiple, original viewpoints to define requirements
    - conceptual tools for analysis and design of complex systems
  - Multi-source, multi-purpose models / technologies
    - well-founded selection / positioning of models / technologies
  - Mediated interaction
    - the role of artifacts
    - artifacts vs. middle agents

# Essential Literature: Some Books

- A. Omicini, F. Zambonelli, M. Klusch, R. Tolksdorf (Eds.). Coordination of Internet Agents: Models, Technologies, and Applications. Springer-Verlag , March 2001.
  - collect different perspectives/surveys on coordination aspects for Internet Agents
- S. Ossowski. Co-ordination in Artificial Agent Societies . LNAI 1535 . Springer, 1999
  - surveys on co-ordination mechanisms for AI agents
- Jacques Ferber. Multi-Agent System: An Introduction to Distributed Artificial Intelligence. Addison Wesley Longman, 1999
  - focused on MAS organisation and coordination
- Weiss (Eds.). Multiagent Systems: A modern approach to DAI. MIT Press, 1999
  - contains chapters providing surveys on basic MAS coordination issues
- Bonabeau et al, "Swarm Intelligence: from Natural to Artificial Systems",Oxford Univ, 1999
  - swarming coordination
- Bonnie Nardi. "Context and Consciousness". MIT Press. 1996

# Essential Literature:

## Some Surveys & Foundations (1)

- L. Gasser. "DAI Approaches to coordination" in Distributed Artificial Intelligence: Theory and Praxis, N.M. Avouris and L. Gasser, Eds. Dordrecht, The Netherlands: Kluwer Academic Publishers, 1992, pp. 31-51.
- Edmund Durfee, "Organizations, Plans and Schedules: An Interdisciplinary Perspective on Coordinating AI Agents", Journal of Intelligent Systems , Special Issue on the Social Context of Intelligent Systems, 3(2-4):157-187, 1993
- Nick Jennings, "Commitments and Conventions: The Foundation of Coordination in MAS", The Knowledge Engineering Review 8(3), 1993
- Thomas Malone and Kevin Crowston, "The Interdisciplinary Study of Coordination", ACM Computing Survey, Vol 26, No 1, March 1994
- Michael P. Wellman. "Market-oriented programming: some early lessons". In S. H. Clearwater, editor, Market-based control: a paradigm for distributed resource allocation, chapter 4. World Scientific, 1995
- K. Schmidt and C. Simone. "Coordination mechanisms: Towards a conceptual foundation of CSCW systems design". International Journal of Computer Supported Cooperative Work (CSCW), 5(2-3):155-200, 1996
- V.D.H Parunak, "Go to the Ant": Engineering Principles from Natural Agent Systems, (1/97), Annals of Operations Research 75, 1997, pp. 69-101.

# Essential Literature:

## Some Surveys & Foundations (2)

- H. Nwana, L. Lee, and N. R. Jennings. Co-ordination in multi-agent systems. In H. Nwana and N. Azarmi, editors, *Software Agents and Soft Computing*, volume 1198 of LNAI. Springer-Verlag, 1997.
- Victor Lesser, "Reflections on the Nature of Multi-Agent Coordination and Its Implications for an Agent Architecture", JAAMAS 1998
- C. Castelfranchi. "Modelling Social Action for AI agents". *Artificial Intelligence*, 103, 157--182, 1998
- Edmund H. Durfee. "Practically Coordinating" *AI Magazine* 20 (1):99-116, Spring 1999
- Robert Tolksdorf. "Models of Coordination", *Engineering Societies in an Agent World I*, LNAI 1972, Springer Verlag, 2000.
- Piotr J. Gmytrasiewicz and Edmund H. Durfee. "Rational Coordination in Multi-Agent Systems. ", *Autonomous Agents and Multi-Agent Systems Journal*, 3(4):319-350, December 2000.
- C. Castelfranchi, "Engineering Social Order", In *Engineering Societies in an Agent World I*, LNAI 1972, Springer Verlag, 2000.
- G. Papadopoulos, "Models and Technologies for the Coordination of Internet Agents: A Survey" in *Coordination of Internet Agents*, Omicini et al, Eds, Springer Verlag, 2001.
- Edmund H. Durfee. "Scaling Up Agent Coordination Strategies." *IEEE Computer* 34(7): 39-46, July 2001.

# Essential Literature:

## Some Surveys & Foundations (3)

- M. Klusch ,K. Sycara , "Brokering and Matchmaking for Coordination of Agent Societies: A Survey" in Coordination of Internet Agents, Omicini et al, Eds, Springer Verlag, 2001.
- D. Deugo, M. Weiss ,E. Kendall. "Reusable Patterns for Agent Coordination " in Coordination of Internet Agents, Omicini et al, Eds, Springer Verlag, 2001.
- U. Dayal, M. Hsu, and L. Rivka. "Business process coordination: State of the art, trends and open issues". In M. G. Apers, P. Atzeni, S. Ceri, S. Paraboschi, K. Ramamohanarao, and R. T. Snodgrass, editors, Proceedings of the 27th VLDB Conference, pages 3P13. Morgan Kaufmann, Sept. 2001
- R.S. Cost ,Y. Labrou ,T. Finin. "Coordinating Agents using Agent Communication Languages Conversations" in Coordination of Internet Agents, Omicini et al, Eds, Springer Verlag, 2001.
- N. Busi, P. Ciancarini, R. Gorrieri, G. Zavattaro. "Coordination Models: A Guided Tour" in Coordination of Internet Agents, Omicini et al, Eds, Springer Verlag, 2001.
- V. Dignum, F. Dignum, "Modeling agent societies: co-ordination frameworks and institutions", Progress in Artificial Intelligence. P. Brazdil, A. Jorge (eds.), Proceedings of the 10 th Portuguese Conference in Artificial Intelligence. Lecture Notes in Artificial Intelligence , Springer-Verlag, Volume 2258, 2001.



# Essential Literature:

## Some Surveys & Foundations (4)

- Keith Decker, "Coordinating Intelligent Agents", Foundations and Applications of Multi-Agent Systems 2002: 1-18
- A. Ricci, A. Omicini, E. Denti. "Activity Theory as a Framework for MAS Coordination", LNAI 2577, Springer Verlag, 2002.
- Marco Mamei , Franco Zambonelli, and Letizia Leonardi, "Co-Fields: Towards a Unifying Approach to the Engineering of Swarm Intelligent Systems", LNAI 2577, Springer Verlag, 2002
- Omicini and Ossowski, "Objective versus Subjective Coordination in the Engineering of Agent Systems" In Intelligent Information Agents: The AgentLink Perspective. LNAI 2586 (State-of-the-Art Survey). Springer-Verlag , March 2003